

Pixsys[®]
ELECTRONICS

CODE:	PPS-0.6BR-513A1
DESCRIPTION:	Pressure transmitter - flush diaphragm - 0..600 mBar F.S. - process connection 1/2" - out 4..20 mA - conn. DIN 43650 Form A
POWER SUPPLY:	12..30 VDC
ISOLATION BETWEEN CASE AND ELECTRICAL CONNECTION:	> 1 MΩ at 50 VDC
ISOLATION VOLTAGE:	350 VAC
SUPPLY CURRENT:	20 mA
WEIGHT:	Approx. 250 g
SEALING:	IP65
MEASURING RANGE:	0..600 mBar Relative
SENSOR TYPE:	Thin film on steel
ELECTRIC CONNECTION:	4 Pole DIN 43650 Form A
SENSOR WORKING TEMP.:	- 30..+ 100°C
ACCURACY:	0,5% F.S. ± 1.2% of Span: 0° C to 50°C
REPEATABILITY:	≤ ± 0,15% F.S.
SHOCK RESISTANCE:	At 20 g / 20ms ≤ 0,1% F.S.
VIBRATION:	≤ 0,1% F.S. for 0..400Hz, 20 g in all directions
OUTPUT:	1 analogue 4..20mA

Ordering Code:

PPS-0.6BR-513A1

Examples: 1.3BR = -1..3 Bar RELATIVE 0.6BR = 0..600 mBar RELATIVE 250BR = 0..250 Bar RELATIVE 0.1BA = 0..100 mBar ABSOLUTE 10BA = 0..10 Bar ABSOLUTE	Range	Electrical Connections 1= M12 4 pin 2= M12 5 pin 3= EN175301-803 Form A (DIN43650, Form A) 4= EN 175301-803 Form C (DIN 43650, Form C)	A1 -1..10 Bar 0..100 mBar 0..200 mBar 0..400 mBar 0..600 mBar 0..1 Bar 0..2,5 Bar 0..4 Bar 0..6 Bar 0..10 Bar 0..25 Bar 0..100 Bar
Pressure connection 1 = 1/4" Gas 2 = 1/2" Gas 3 = 1/4" NPT 4 = 1/2" NPT 5 = 1/2" Gas Flush Membrane 6 = 1" Gas Flush Membrane		Analogue output 1= 4..20 mA 2= 0..10 Volt 3= 0..20 mA	

Pixsys srl

Via Po, 16
30030 - Mellaredo di Pianiga
Venezia - Italia
Tel. +39 041 5190518
Fax +39 041 519002
Mail info@pixsys.net
www.pixsys.net



Manual's code: 2300.10.363
Document version: rel.01
Last update: 30/07/2023
Author: Matteo Cardi

MATERIALS
Process connection
 Stainless steel 316Ti (1.4571)
Diaphragm
 Stainless steel 316Ti (1.4571),
 Hastelloy C
Transmission liquid
 Silicon oil, Halocarbon or Almond oil
Sensor
 Stainless steel diaphragm
 1.4542/1.4548 (17-4PH)
 with polysilicium cell
Case
 Stainless steel 304 (1.4301)

PROCESS CONNECTION
 G 1/2" A male according with
 DIN 3852 with metal seal cone
 at the top



	Function
1	V-
2	V+
3	Shield
4	Ground

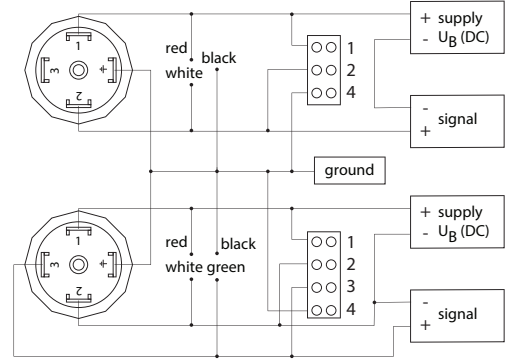
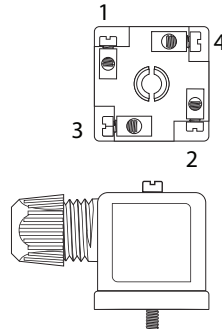

Dimensions are expressed in mm

⚠ WARNING! READ CAREFULLY BEFORE INSTALLATION ⚠

1. GENERAL:

If the PPS is used in a manner not specified by Pixsys srl, the protection provided by the unit may be impaired. A failure resulting in injury or damage may be caused by excessive overpressure, excessive vibration or pressure pulsation, excessive instrument temperature, corrosion of the pressure containing parts, or other misuse. Consult Pixsys srl before installing if there are any questions or concerns.

2. OVERPRESSURE:

Pressure spikes in excess of the rated overpressure capability of the transducer may cause irreversible electrical and/or mechanical damage to the pressure measuring and containing elements.

Fluid hammer and surges can destroy any pressure transducer and must always be avoided. A pressure snubber should be installed to eliminate the damaging hammer effects. Fluid hammer occurs when a liquid flow is suddenly stopped, as with quick closing solenoid valves. Surges occur when flow is suddenly begun, as when a pump is turned on at full power or a valve is quickly opened.

Liquid surges are particularly damaging to pressure transducers if the pipe is originally empty. To avoid damaging surges, fluid lines should remain full (if possible), pumps should be brought up to power slowly, and valves opened slowly. To avoid damage from both fluid hammer and surges, a surge chamber should be installed.

Symptoms of fluid hammer and surge's damaging effects:

- Pressure transducer exhibits an output at zero pressure (large zero offset).
- Pressure transducer output remains constant regardless of pressure
- In severe cases, there will be no output.

FREEZING:

Prohibit freezing of media in pressure port. Unit should be drained (mount in vertical position with electrical termination upward) to prevent possible overpressure damage from frozen media.

3. STATIC ELECTRICAL CHARGES:

Any electrical device may be susceptible to damage when exposed to static electrical charges. To avoid damage to the transducer observe the following:

- Ground the body of the transducer BEFORE making any electrical connections.
- When disconnecting, remove the ground LAST!

Note: The shield and drain wire in the cable (if supplied) is not connected to the transducer body, and is not a suitable ground.

DESCRIPTION

The Model PPS pressure transducers are high performance instruments intended for use in industrial applications where the process media is compatible with the 17-4PH Stainless steel sensor material and either the 304 Stainless steel, carbon steel, brass or aluminum process connection depending on which option is used.

MECHANICAL INSTALLATION

Environmental

The PPS pressure transducer can be stored and used within the temperature limits of -40 °C to 125 °C (-40 °F to 257 °F). Ingress protection ratings of the units are dependent on the electrical termination specified. Refer to the wiring diagrams on the reverse for the IP rating of the unit which is being installed.

Mounting

The PPS pressure transducers require no special mounting hardware and can be mounted in any orientation with negligible position error. Although the units can withstand considerable vibration without damage or significant output effects, it is always good practice to mount the transducer where there is minimum vibration. For units with NPT type pressure fittings apply sealing tape or an equivalent sealant to the threads before installing. When installing or removing the unit apply a wrench to the hex wrench flats, located above the pressure fitting.

DO NOT tighten by using a pipe wrench on the housing. A 27mm (1 1/16") wrench can be used on the wrench flats of the hex.

Electro-Magnetic Interference

The circuitry of the PPS pressure transducers is designed to minimize the effect of electromagnetic and radio frequency interference. To minimize susceptibility to noise, avoid running the termination wiring in a conduit which contains high current AC power cables. Where possible avoid running the termination wiring near inductive equipment.

Field Adjustments

The PPS pressure transducers are precisely calibrated and temperature compensated at the factory to ensure long and stable performance. There are no field accessible adjustments on the transducers.

PPS ELECTRICAL INSTALLATION

Wiring Diagram

(see following pages for further details)

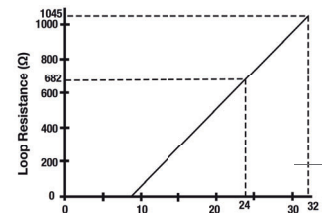
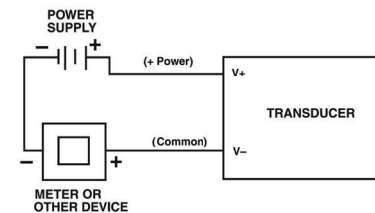

Power Supply Requirements:

Output Signal
4-20 mA

Min Supply
9 Vdc

Max Supply
32 Vdc

Where shielded wiring is being used, connect the drainwire to the guard terminal on the read out device or measuring instrument if available. In all other cases connect to the ground of the power supply negative terminal.

For transmitters with 4-20 mA output signal, the minimum voltage at the terminals is 9 Vdc. However, the minimum supply voltage should be calculated using the graph here above and the following formula:

$$V_{MIN} = 9V + [0.022A * x (RL)]$$

(*includes a 10% safety factor)

$RL = RS + RW$

$RL = \text{Loop Resistance (Ohms)}$

$RS = \text{Sense Resistance (Ohms)}$

4. MEDIA COMPATIBILITY & GALVANIC COMPATIBILITY

All configurations of the PPS that utilize housing/fitting materials including zinc plated carbon steel, brass and aluminum are dissimilar to the 17-4PH Stainless steel sensor element. Both the housing/fitting material and the sensor element are in direct contact with the process media. If the process media is an electrolytic solution, galvanic corrosion may occur. Selected materials should be carefully reviewed by the user of this product for both individual chemical compatibility with the process media, as well as combined use to avoid galvanic corrosion.

COMPLIANCE

